

Technical Data Sheet

Opto Interrupter

ITR20510/TR8

■ Features

- Fast response time
- High sensitivity
- Cut-Off visible wavelength
- Thin
- Compact
- Pb free
- This product itself will remain within RoHS compliant version.



■ Descriptions

ITR20510/TR8 is a light reflection switch which includes a GaAs IR-LED transmitter and a NPN photo-transistor with a high photosensitive receiver for short distance, operating in the infrared range. Both components are mounted side- by- side in a plastic package.

■ Applications

- Camera
- VCR
- Floppy disk driver
- Cassette type recorder
- Various microcomputer control equipment

■ Device Selection Guide

| Device No. | Chip Material |
|------------|---------------|
| IR | GaAs |
| PT | Silicon |



Technical Data Sheet

Opto Interrupter

ITR20510/TR8

Package Dimensions

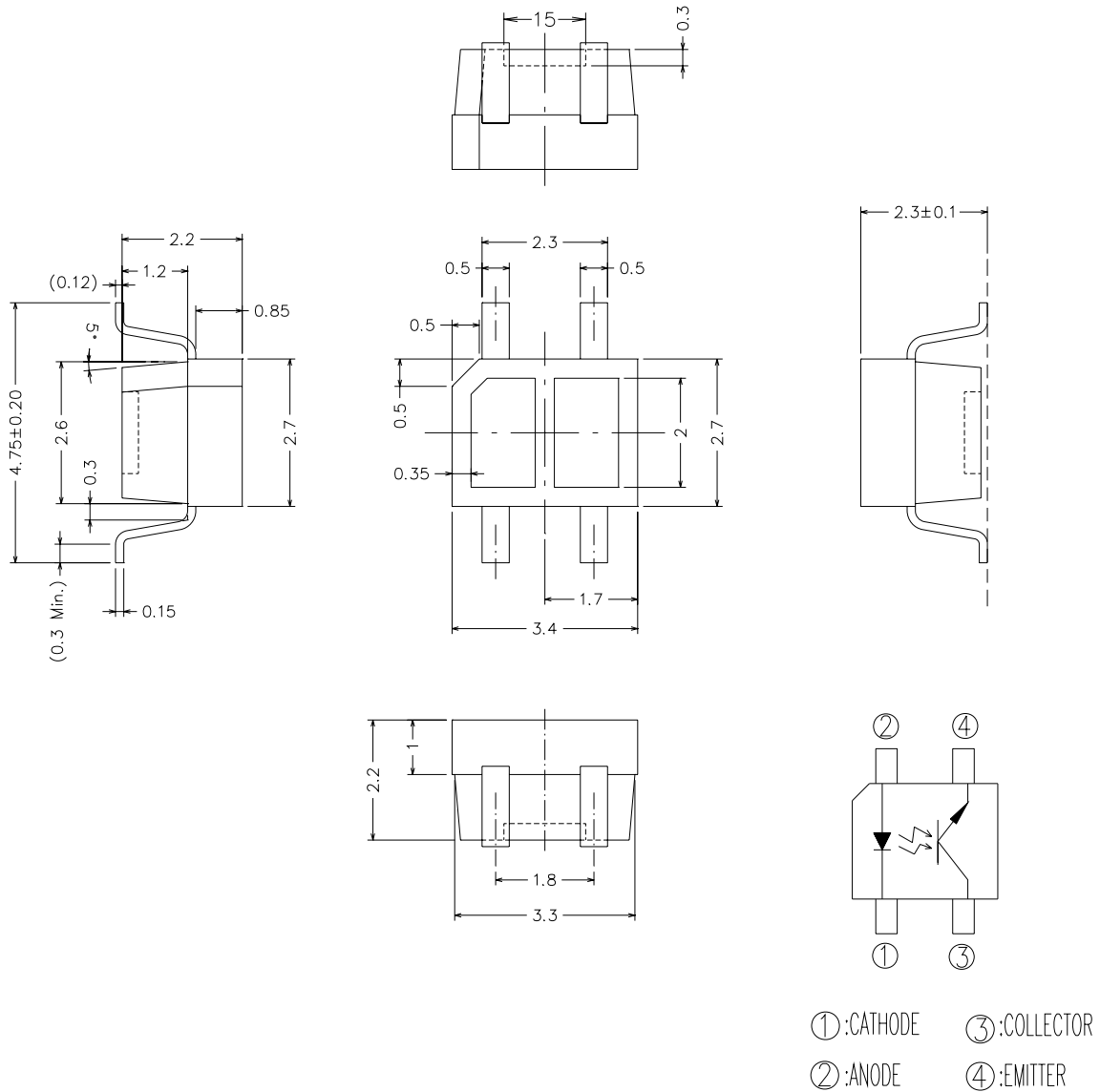

- Notes:** 1. All dimensions are in millimeters
2. Tolerances unless dimensions $\pm 0.15\text{mm}$



Technical Data Sheet

Opto Interrupter

ITR20510/TR8

■ Absolute Maximum Ratings (Ta=25°C)

| Parameter | | Symbol | Ratings | Unit |
|---------------------------------|--|--------------------|---------|------|
| Input | Power Dissipation at(or below) 25°C Free Air Temperature | Pd | 75 | mW |
| | Reverse Voltage | V _R | 5 | V |
| | Forward Current | I _F | 50 | mA |
| | Peak Forward Current (*1) Pulse width ≤ 100 μs, Duty cycle=1% | I _{FP} | 1 | A |
| | Collector Power Dissipation | P _C | 75 | mW |
| Output | Collector Current | I _C | 50 | mA |
| | Collector-Emitter Voltage | B V _{CEO} | 30 | V |
| | Emitter-Collector Voltage | B V _{ECO} | 5 | V |
| | Operating Temperature | T _{opr} | -25~+85 | °C |
| Storage Temperature | T _{stg} | -30~+90 | °C | |
| Lead Soldering Temperature (*2) | T _{sol} | 260 | °C | |

(*1) $t_w=100 \mu \text{ sec.}$, $T=10 \text{ msec.}$ (*2) $t=5 \text{ Sec}$

■ Electro-Optical Characteristics (Ta=25°C)

| Parameter | | Symbol | Min. | Typ. | Max. | Unit | Conditions |
|--------------------------|------------------------|----------------------|------|------|------|------|---|
| Input | Forward Voltage | V _F | --- | 1.2 | 1.6 | V | I _F =20mA |
| | Reverse Current | I _R | --- | --- | 10 | μA | V _R =5V |
| | Peak Wavelength | λ _p | --- | 940 | --- | nm | --- |
| Output | Dark Current | I _{CEO} | --- | --- | 100 | nA | V _{CE} =10V |
| | C-E Saturation Voltage | V _{CE(sat)} | --- | --- | 0.4 | V | I _C =2mA ,E _e =1mW/cm ² |
| Transfer Characteristics | Light Current | I _{C(ON)} | 0.1 | --- | --- | mA | V _{CE} =5V |
| | Leakage Current | I _{CEOD} | --- | --- | 1 | μA | I _F =20mA |
| | Rise time | t _r | --- | 20 | --- | μsec | V _{CE} =2V |
| | Fall time | t _f | --- | 20 | --- | μsec | I _C =100 μA R _L =1KΩ |

Typical Electrical/Optical/Characteristics Curves for IR

Fig. 1 Forward Current vs. Ambient Temperature

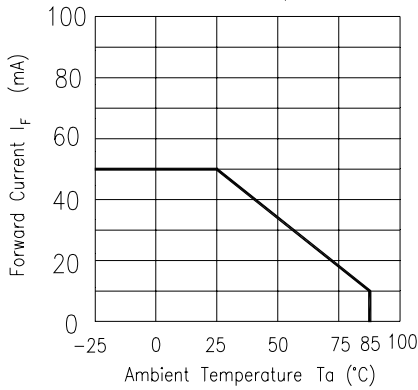

Fig. 2 Spectral Distribution

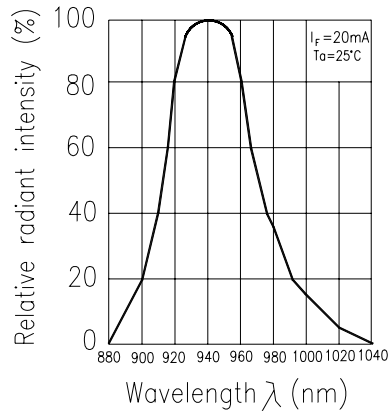

Fig. 3 Peak Emission Wavelength vs. Ambient Temperature

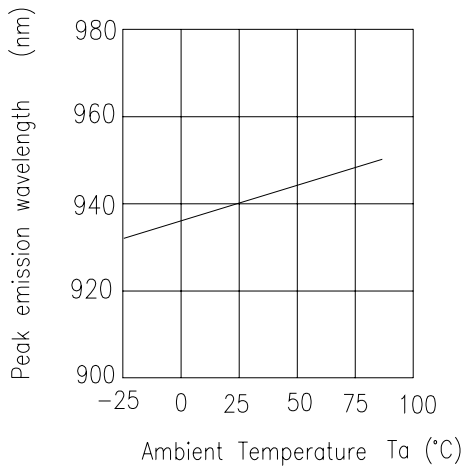

Fig. 4 Forward Current vs. Forward Voltage

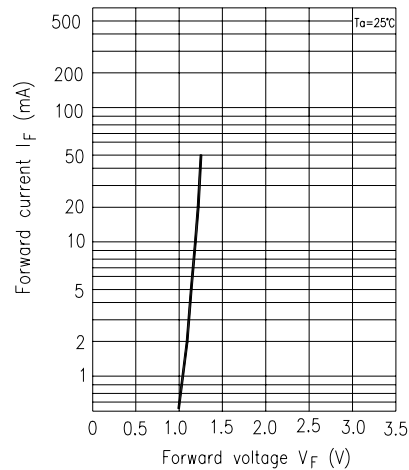

Fig. 5 Forward Voltage vs. Ambient Temperature

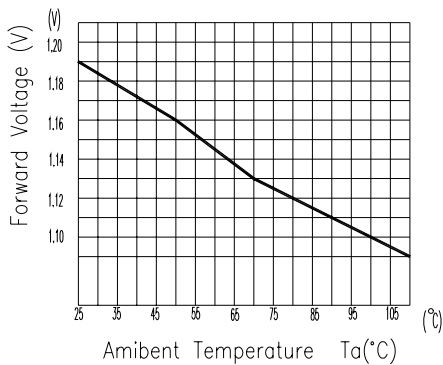
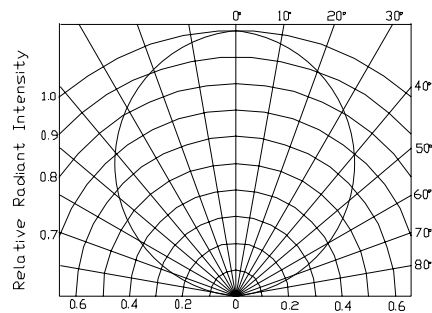

Fig. 6 Relative Radiant Intensity vs. Angular Displacement



Typical Electro/Optical/Characteristics Curves for PT

Fig.1 Collector Power Dissipation vs. Ambient Temperature

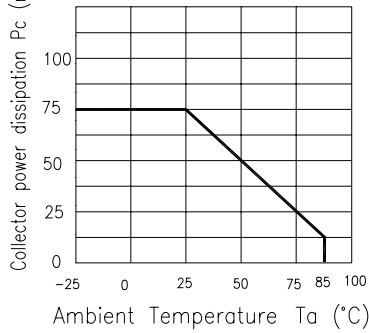

Fig.2 Collector Dark Current vs. Ambient Temperature

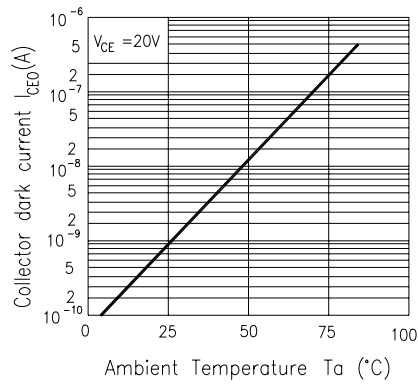

Fig. 3 Relative Collector Current vs. Ambient Temperature

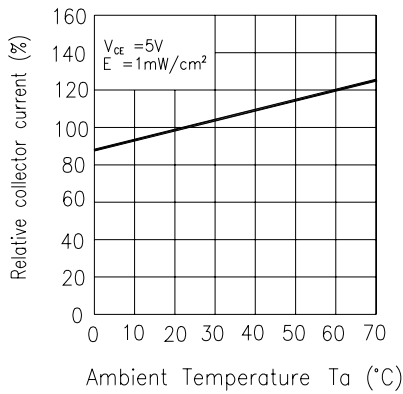

Fig.4 Collector Current vs. Irradiance

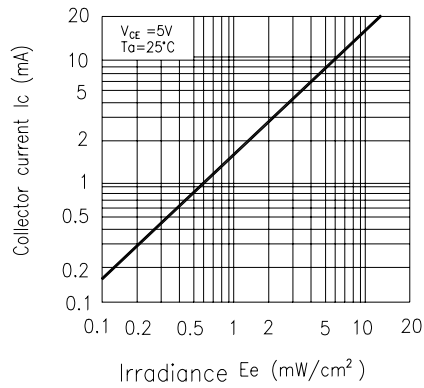

Fig.5 Spectral Sensitivity

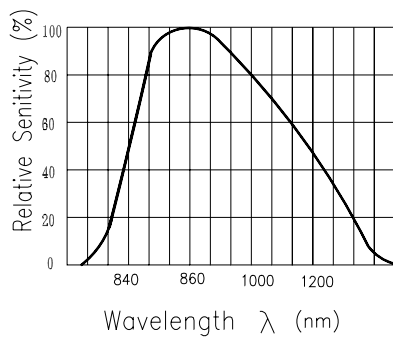
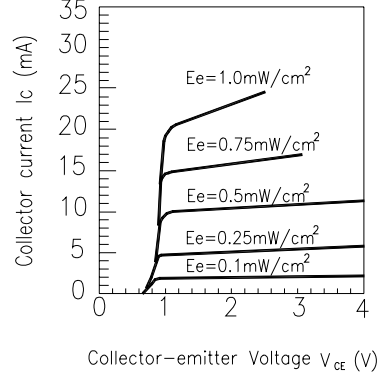

Fig.6 Collector Current vs. Collector-emitter Voltage



Typical Electrical/Optical/Characteristics Curves For ITR

Fig.1 Relative Collector Current vs. Distance between Sensor and Al Evaporation Galss

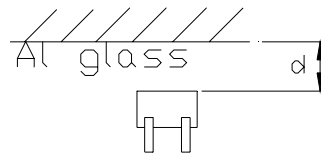
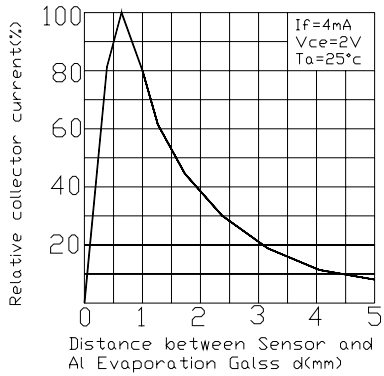

Fig.2 Relative Collector Current vs. Card Moving Distance (l)

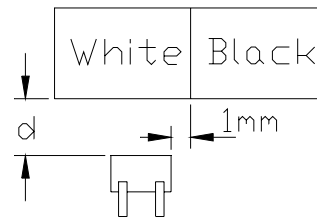
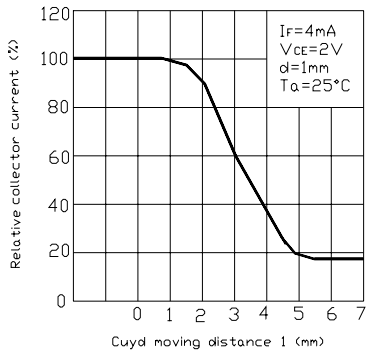
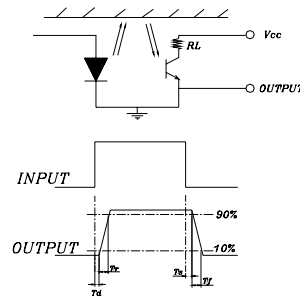
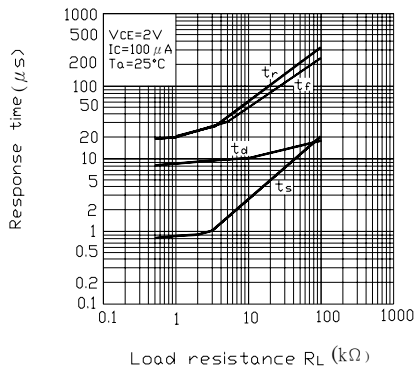

Fig.3 Response Time vs. Load Resistance





Technical Data Sheet

Opto Interrupter

ITR20510/TR8

Reliability Test Item And Condition

The reliability of products shall be satisfied with items listed below.

Confidence level : 90%

LTPD : 10%

| NO. | Item | Test Conditions | Test Hours/ Cycles | Sample Sizes | Failure Judgement Criteria | Ac/Re |
|-----|------------------------------------|---|-----------------------|-----------------|---|-------|
| 1 | Solder Heat | TEMP. : $260^{\circ}\text{C} \pm 5^{\circ}\text{C}$ | 10secs | 22pcs | | 0/1 |
| 2 | Temperature Cycle | H : $+85^{\circ}\text{C}$ 30mins ↕ 5mins ↕ L : -30°C 30mins | 50Cycles | 22pcs | $I_R \geq U \times 2$ $E_e \leq L \times 0.8$ $V_F \geq U \times 1.2$ | 0/1 |
| 3 | Thermal Shock | H : $+85^{\circ}\text{C}$ 5mins ↕ 10secs ↕ L : -10°C 5mins | 50Cycles | 22pcs | U : Upper Specification | 0/1 |
| 4 | High Temperature Storage | TEMP. : $+90^{\circ}\text{C}$ | 1000hrs | 22pcs | Limit | 0/1 |
| 5 | Low Temperature Storage | TEMP. : -30°C | 1000hrs | 22pcs | L : Lower Specification | 0/1 |
| 6 | DC Operating Life | $I_F = 20\text{mA}$ | 1000hrs | 22pcs | Limit | 0/1 |
| 7 | High Temperature/ High Humidity | $85^{\circ}\text{C} / 85\% \text{ R.H}$ | 1000hrs | 22pcs | | 0/1 |

Recommended Method of Storage

The following are general recommendations for moisture sensitive level (MSL) 4 storage and use:

- Shelf life in sealed bag: 12 months at $< 40^{\circ}\text{C}$ and $< 90\%$ relative humidity (RH)
- After bag is opened, devices that will be subjected to reflow solder or other high temperature process must
 - a) Mounted within 72 hours of factory conditions $< 30^{\circ}\text{C}/60\%RH$, or
 - b) Stored at $< 20\%$ RH
- Devices require bake, before mounting, if:
Humidity Indicator Card is $> 20\%$ when read at $23 \pm 5^{\circ}\text{C}$
- If baking is required, devices may be baked:
 - a) 192 hours at 40°C , and $< 5\%$ RH (dry air/nitrogen) or
 - b) 96 hours at 60°C , and $< 5\%$ RH for all device containers
 - c) 24 hours at 125°C
- Soldering Condition
 - a) Pb-free solder temperature profile

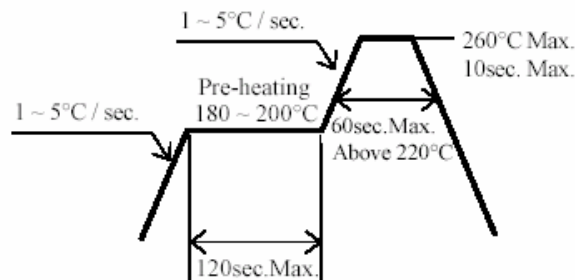

- b) Reflow soldering should not be done more than two times.
 - c) When soldering, do not put stress on the LEDs during heating.
 - d) After soldering, do not warp the circuit board.
- Repairing

Repair should not be done after the LEDs have been soldered. When repairing is unavoidable, a double-head soldering iron should be used (as below figure). It should be confirmed beforehand whether the characteristics of the LEDs will or will not be damaged by repairing.

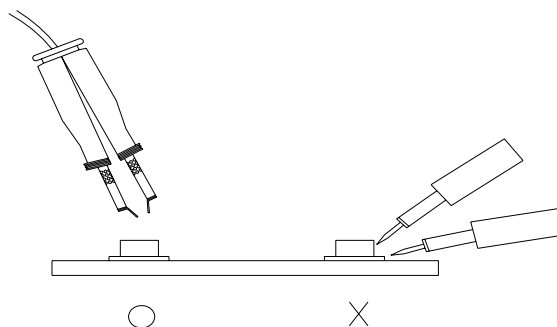



Technical Data Sheet

Opto Interrupter

ITR20510/TR8

Taping Dimension

Progressive direction

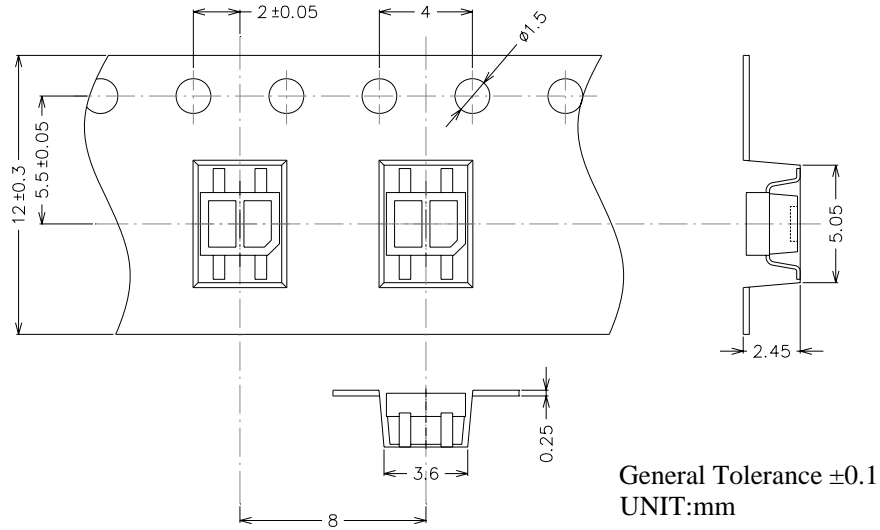

Reel Dimensions

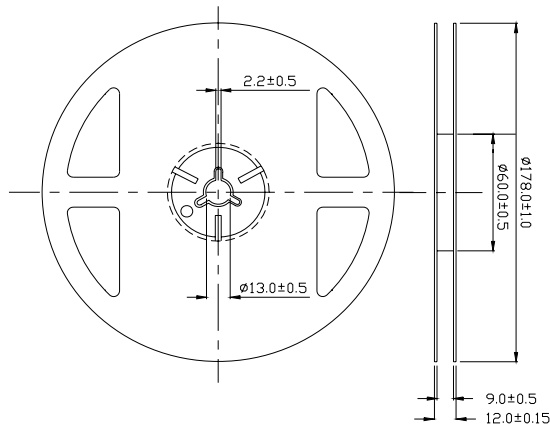

Note: The tolerances unless mentioned is ± 0.1 mm ,Unit = mm

Moisture Resistant Packaging

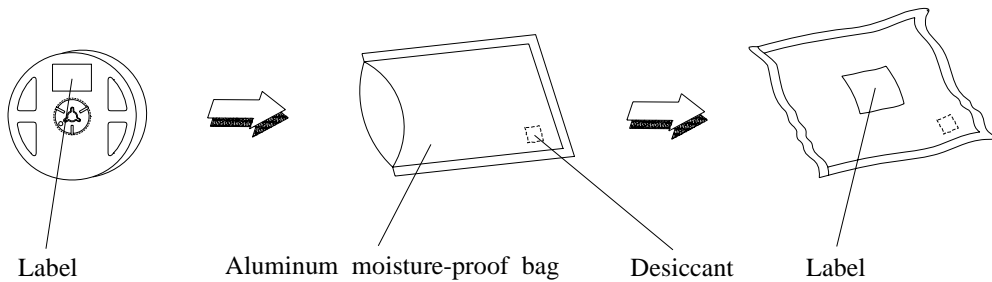



Technical Data Sheet

Opto Interrupter

ITR20510/TR8

Packing Quantity Specification

1. 500 Pcs/ 1Reel
2. 15 Reel /1 Box
3. 2 Box/ 1 Carton

Label Form Specification

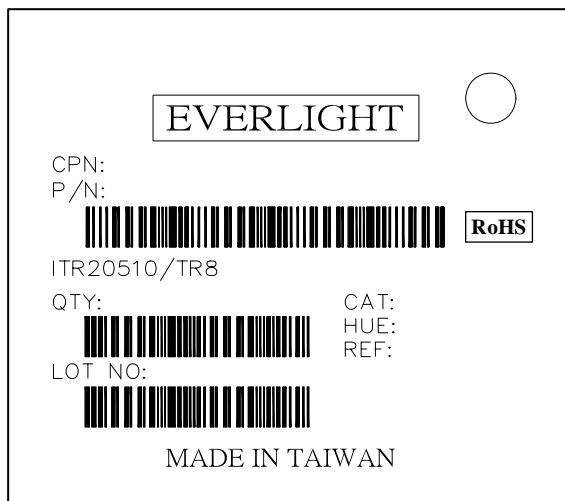

CPN: Customer's Production Number
P/N : Production Number
QTY: Packing Quantity
CAT: None
HUE: None
REF: Reference
LOT No: Lot Number
MADE IN TAIWAN: Production Place

Notes

1. Above specification may be changed without notice. EVERLIGHT will reserve authority on material change for above specification.
2. When using this product, please observe the absolute maximum ratings and the instructions for using outlined in these specification sheets. EVERLIGHT assumes no responsibility for any damage resulting from use of the product which does not comply with the absolute maximum ratings and the instructions included in these specification sheets.
3. These specification sheets include materials protected under copyright of EVERLIGHT corporation. Please don't reproduce or cause anyone to reproduce them without EVERLIGHT's consent.

EVERLIGHT ELECTRONICS CO., LTD.
Office: No 25, Lane 76, Sec 3, Chung Yang Rd,
Tucheng, Taipei 236, Taiwan, R.O.C

Tel: 886-2-2267-2000, 2267-9936
Fax: 886-2267-6244, 2267-6189, 2267-6306
<http://www.everlight.com>